



Chair of Lighting, University of Naples Federico II

International Conference

LED LIGHTING TODAY: TALES OR FACTS?

*LED Performance
and Thermal Management*

C. La Mura

OSRAM SpA

Conference Center
University of Naples Federico II
March 13, 2009

*Prestazioni dei LED
e
Thermal
Management*

Napoli 13 marzo 2009

C. La Mura



Caratteristiche principali dei LED



LED SYSTEM | 19/03/2009 | pagina 3

OSRAM 

Lifetime of LED

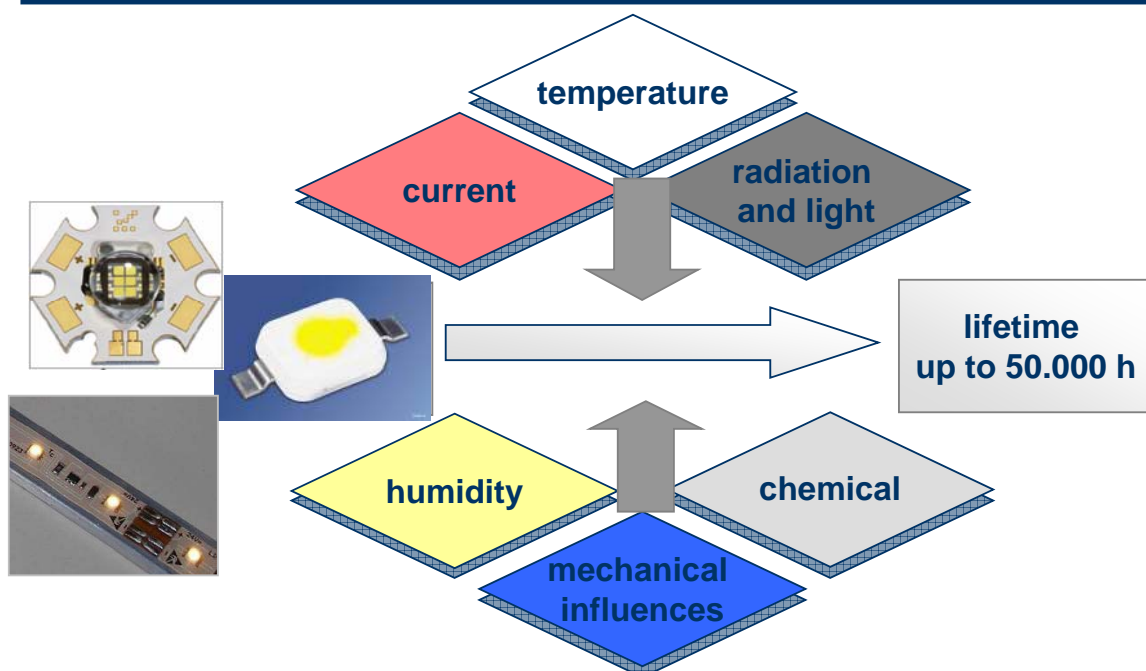

LED SYSTEM | 19/03/2009 | pagina 4

OSRAM 

Evoluzione dei CHIP per una maggior emissione di luce

Standard

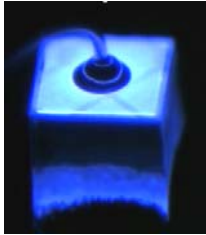

$\eta_{\text{extract.}} = 25\%$

ATON®

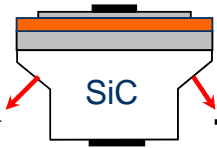

52%

NOTA

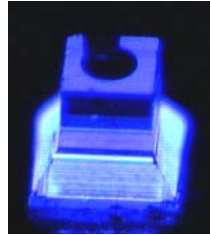
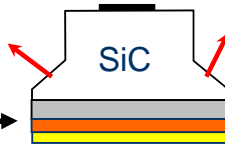

60%

ThinGaN®

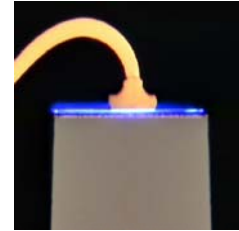
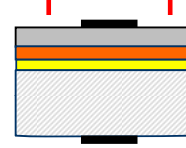

75%
WORLD RECORD

Evoluzione del package per una maggior potenza

High-Power LED Packages

TOPLED®



2 lm 90mW
@ 20mA single chip

Power TOPLED®



3 lm 140mW
@ 30mA single chip

Advanced Power
TOPLED®



10 lm 250mW
@ 200mA single chip

Golden Dragon®



30 lm 1,2W
@ 350mA single chip

OSTAR-Lighting

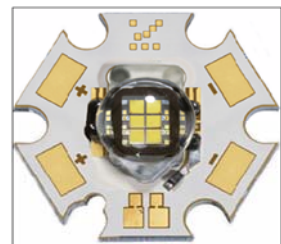

100-1000 lm
10 - 50W
multi chip

Miniature LED Packages



PointLed
3,4 x 0,725mm

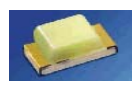

Chiplid
0,8mm



MicroSIDELED®
1,0mm



SmartLED®
0,6mm



Firefly
0,5mm



SmartLED®
0,35mm

Sezione di un LED in tecnologia SMT

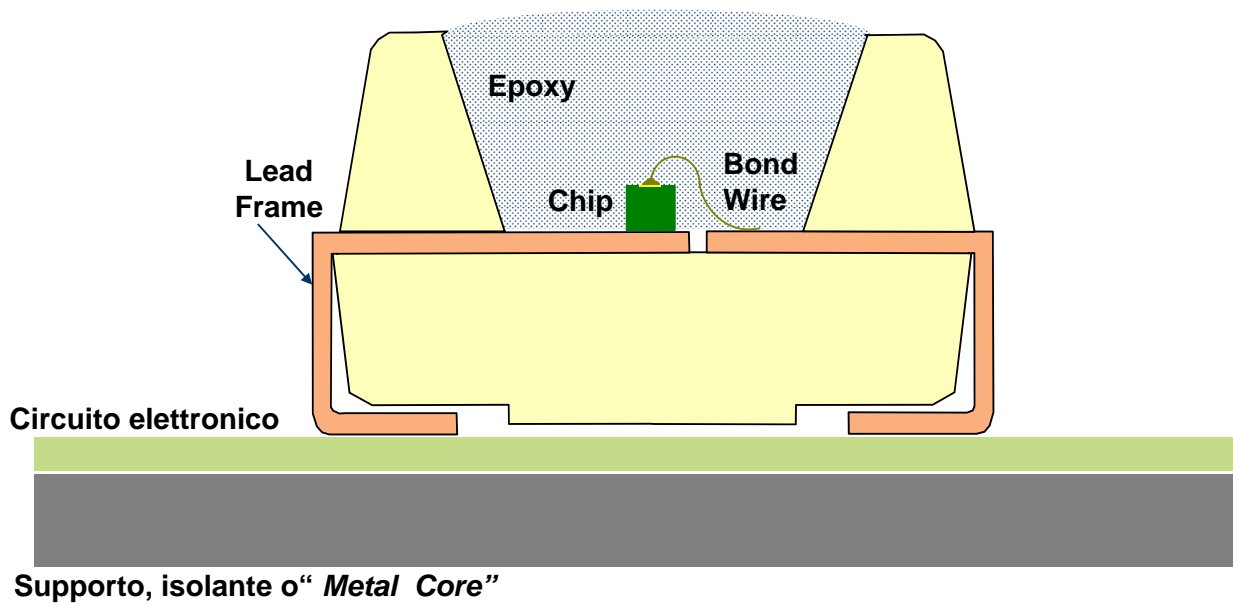

Sezione di un LED in tecnologia SMT

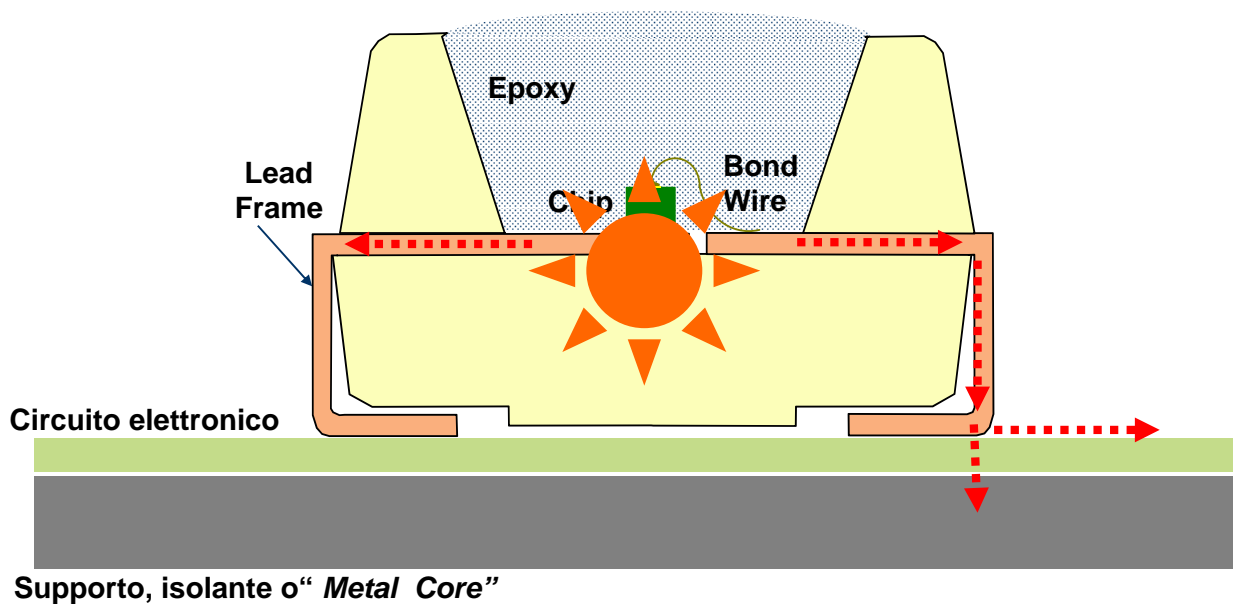

High-Power LED DRAGON

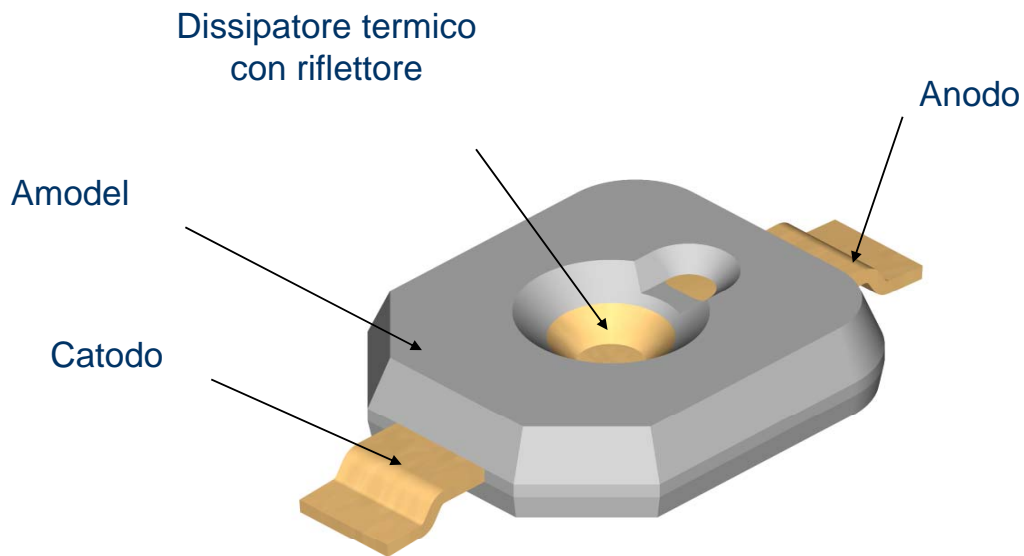

SMT technology

Operation Temperature $-40^{\circ}\text{C} \dots +85^{\circ}\text{C}$

High-Power LED DRAGON

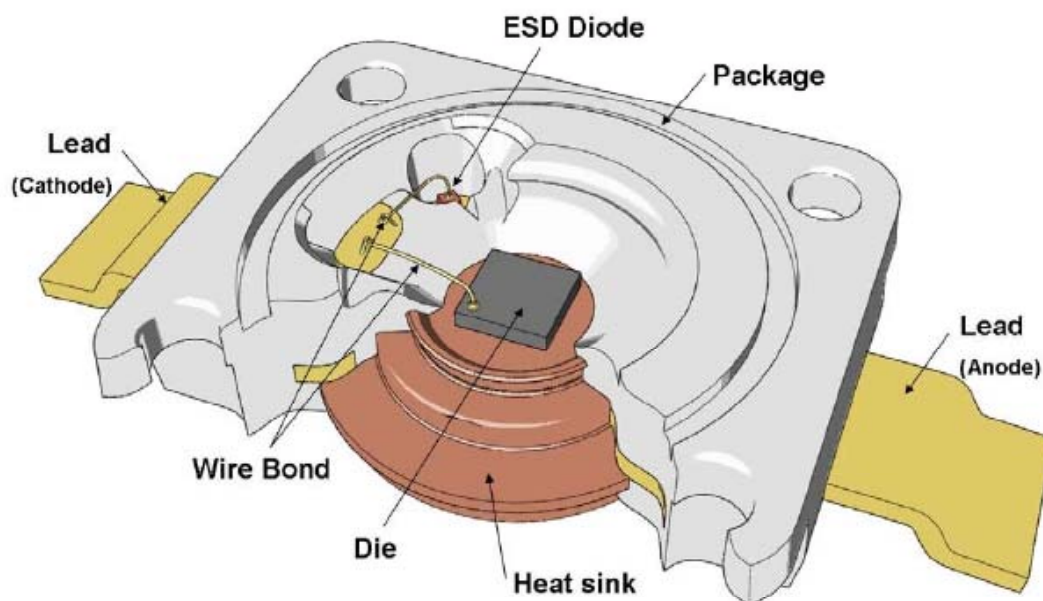

Sezione di un LED in tecnologia SMT METAL CORE

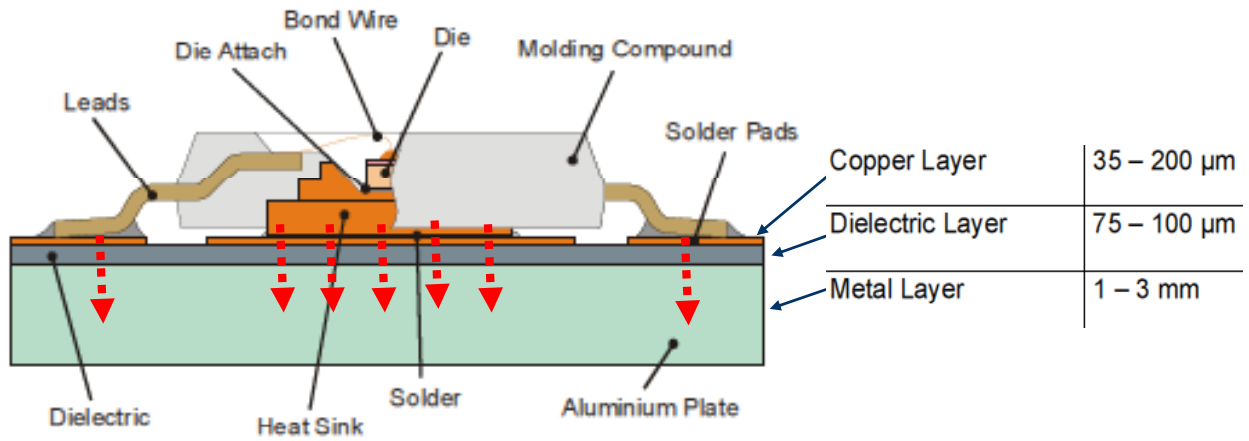

LED Multi Chip OSRAM OSTAR - 15 W - 700 mA

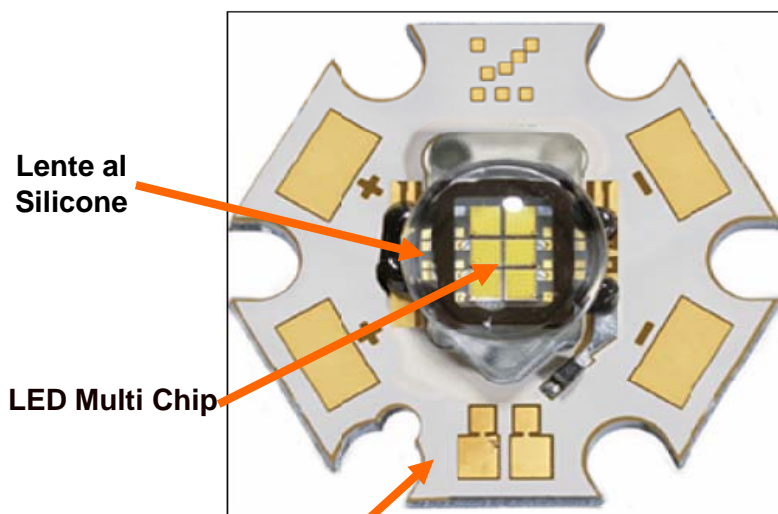

Supporto Multistrato "Metal Core"



Durata dei LED, influenze

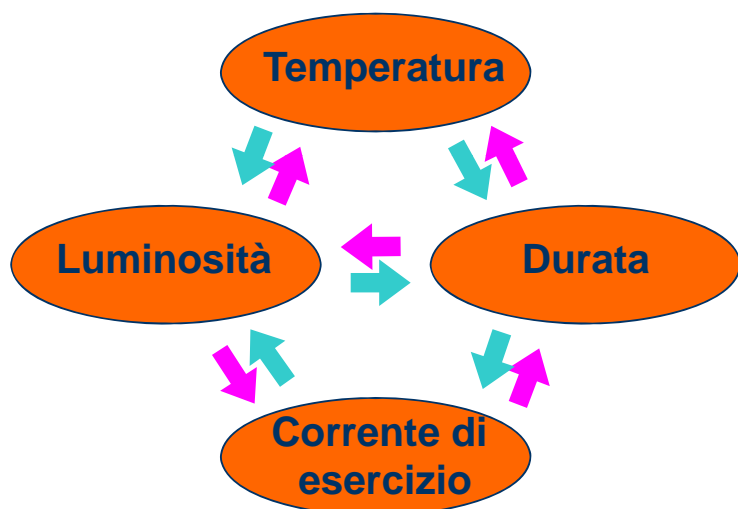

La durata dei LED è fortemente influenzata dalla temperatura di esercizio

Si può stimare la durata dei LED solo misurando l'influenza termica dell'apparecchio in cui sono integrati.

I LED sovraccaricati termicamente hanno maggiori probabilità di malfunzionamento e una minore durata.

Ogni apparecchio con LED è un compromesso

Durata di vita in funzione della temperatura sul Tc

LED TIPO	Tc[°C]	L[thrs]	Tc[°C]	L[thrs]
A	40°	>70	80°	60
B	40°	>70	80°	45
C	25°	>50	65°	45
D	25°	>50	65°	30

La durata dei LED è in relazione alla temperatura presente sul punto Tc nell'esercizio, e le temperature di riferimento misurate sul punto Tc in laboratorio.

Allo scopo vengono indicate le durate di vita attese per i moduli LED, in funzione di due diverse temperature misurate sullo stesso punto Tc in laboratorio.

Misura della temperatura sul punto di riferimento T_c

Per calcolare la durata di un modulo LED all'interno di un apparecchio di illuminazione, occorre misurare la temperatura sul punto di riferimento T_c durante l'esercizio.

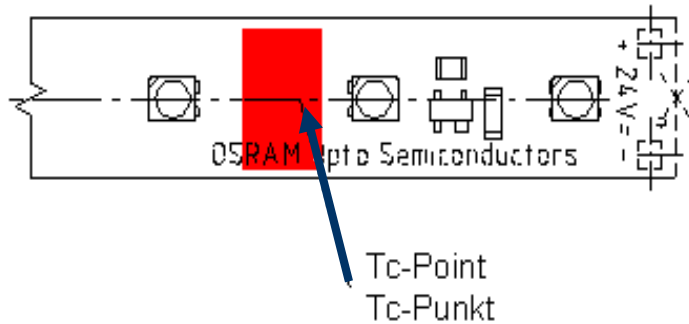

Modulo LED lineare

Flexible high power LED module – Expected life time

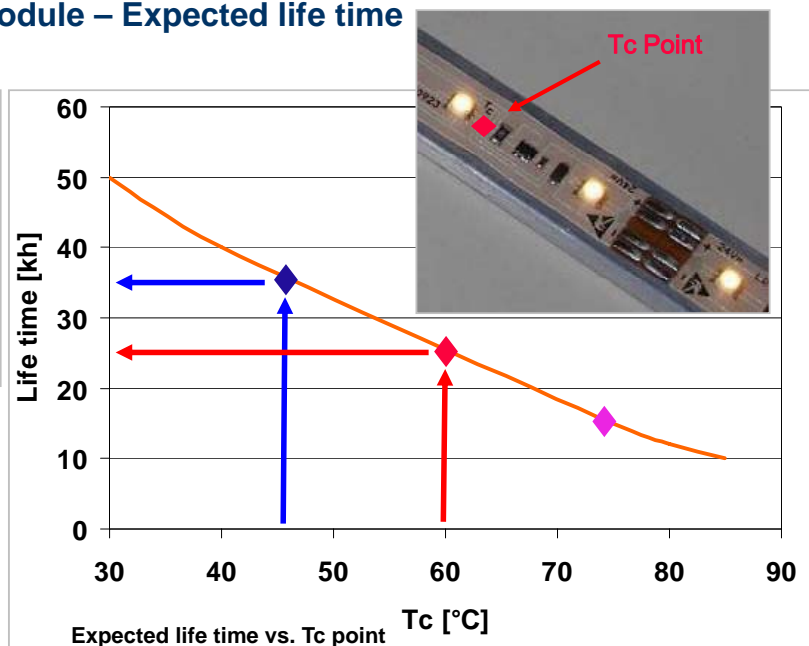
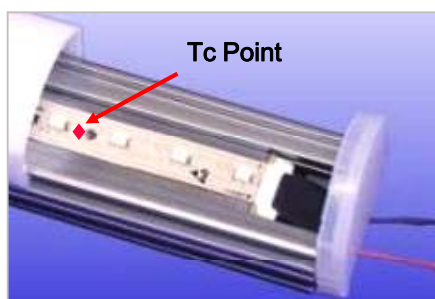
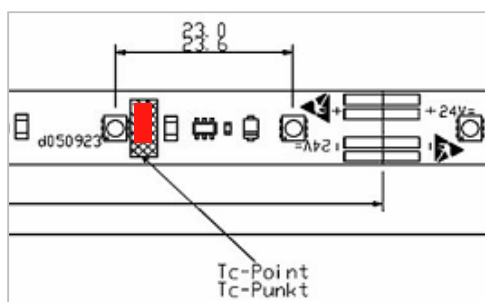

Punto di misura Tc su Moduli con Golden DRAGON

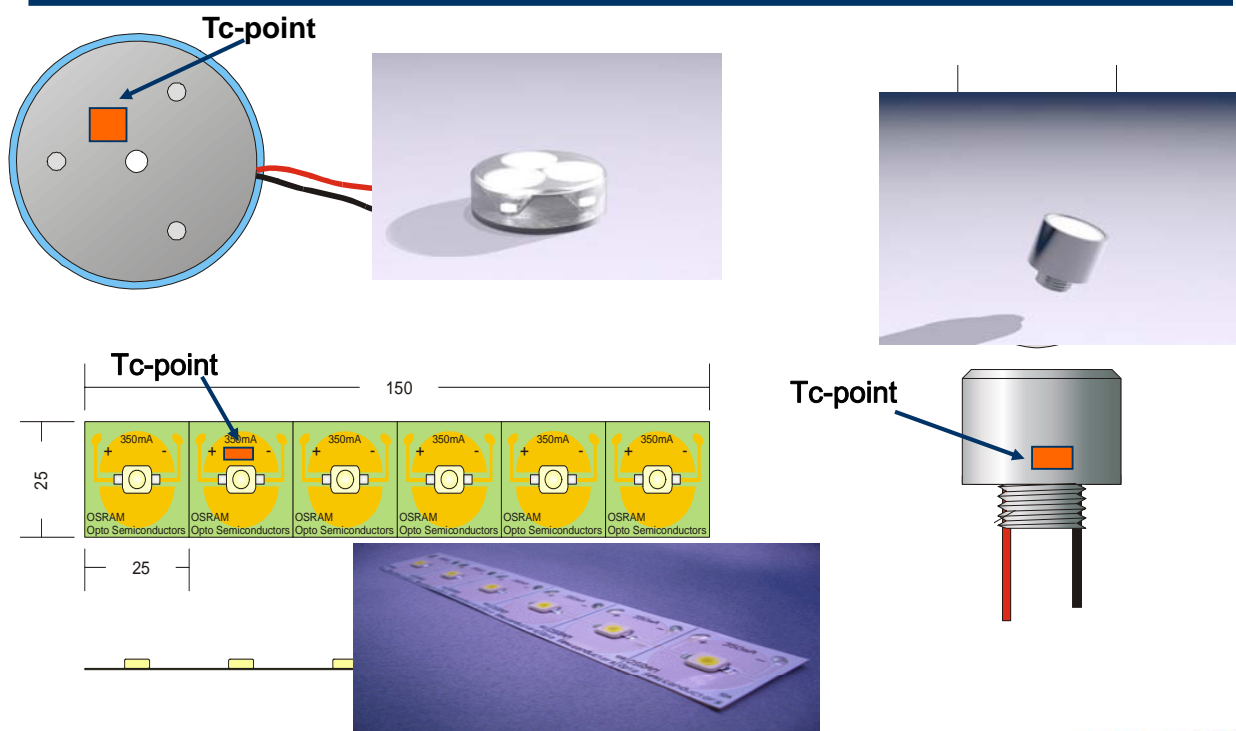

Design termico moduli high-flux

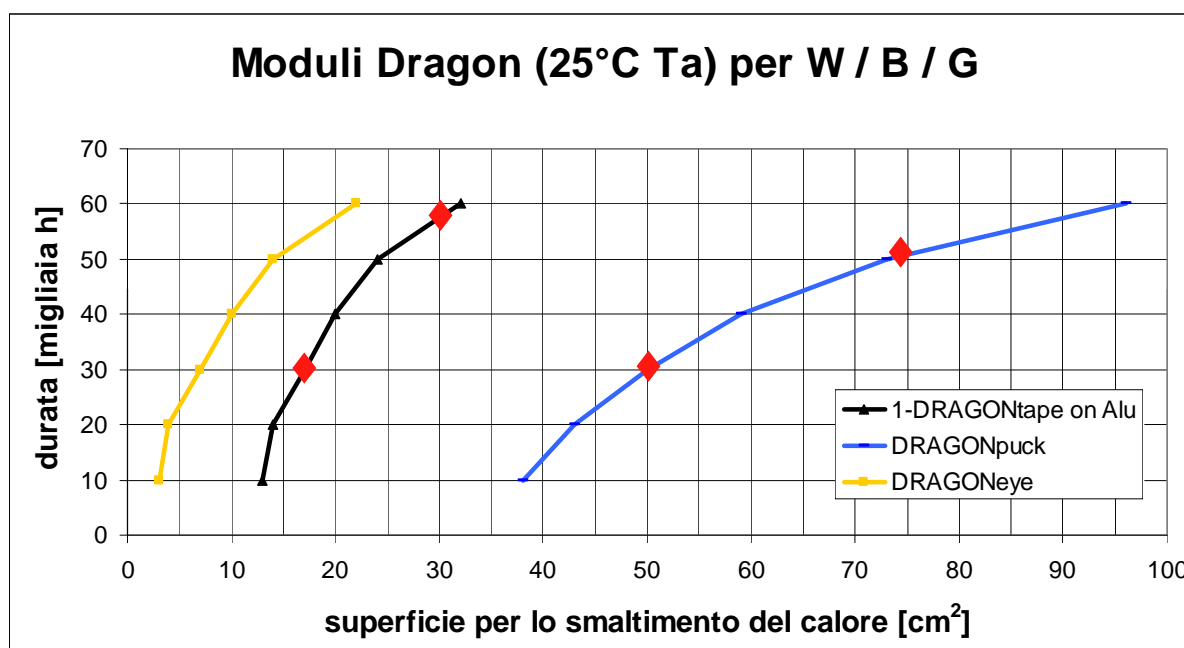

LINEARlight con Golden DRAGON®



PROGETTO TERMICO INTEGRATO

1. Supporto per ottica + ottica
2. Golden DRAGON® su METAL CORE
3. Corpo dissipatore di calore

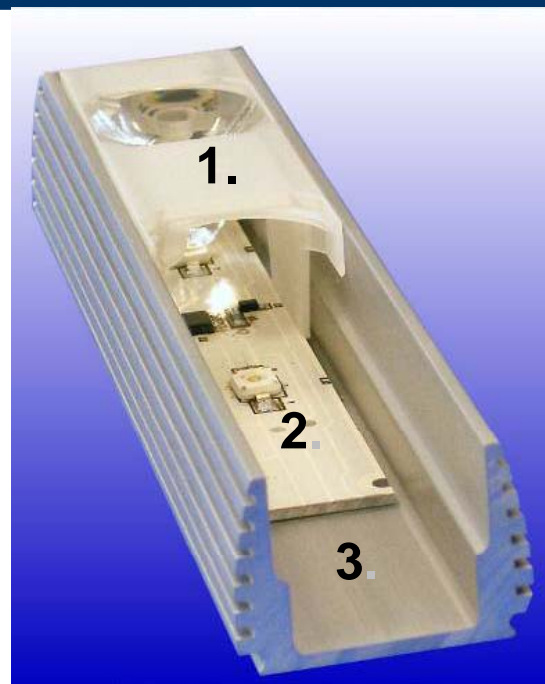

COINlight-OSTAR®

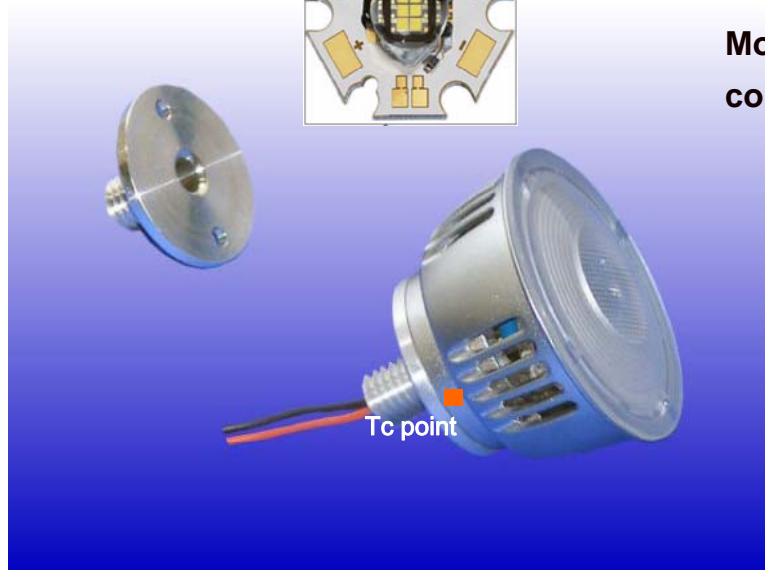
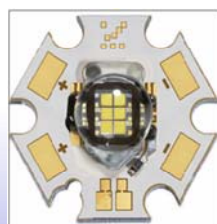

Modulo LED di potenza OSTAR®
con dissipatore primario e ottica

- Potenza: 12 W - 24 V d.c.
- Intensità luminosa: 700 cd
- Diverse Tonalità di Luce
- Dissipatore addizionale*

COINlight-OSTAR con Dissipatore di calore aggiuntivo



- Dissipatore in alluminio per una corretta gestione della temperatura.

Durata di vita in funzione della temperatura sul Tc

	LED TIPO	Tc[°C]	L[thrs]	Tc[°C]	L[thrs]
	A	40°	>70	80°	60
	B	40°	>70	80°	45
	C	25°	>50	65°	45
	D	25°	>50	65°	30

La durata dei LED è in relazione alla temperatura presente sul punto Tc nell'esercizio, e le temperature di riferimento misurate sul punto Tc in laboratorio.

Cioè la determiniamo col progetto del suo impiego..

Il Thermal Management è un investimento che allunga la vita



Soluzioni complete per l'illuminazione generale?



***Grazie della
vostra attenzione***